

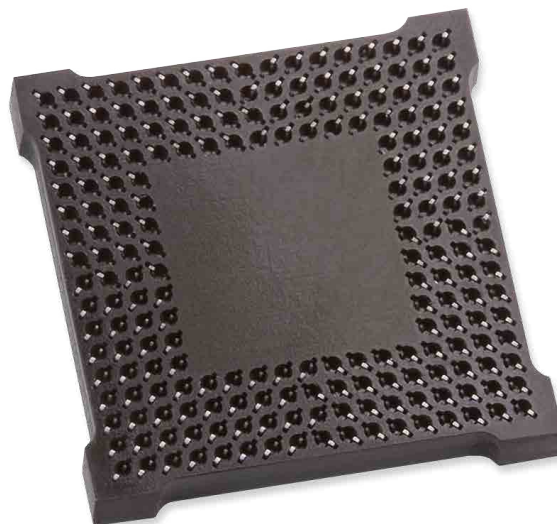

Grypper G80

104468-0016 Contact
0.8 Pitch / 0.45 Ball Diameter



TEST OBJECTIVE

The objective of this report is to determine the RF transmission characteristics of the Ironwood Electronics Grypper G80 socket for the GSG (ground-signal-ground) configurations. Two product variations, Pattern 2A and Pattern 8A, at a pitch of 0.8 mm were studied. Three-dimensional electromagnetic (EM) field models were simulated for sockets with three contacts embedded in the dielectric material at a pitch of 0.8 mm and using a ball diameter of 0.45 mm. Three-dimensional EM field models were also simulated for sockets with nine contacts, one signal contact surrounded by eight ground contacts, at the 0.8 mm pitch. Schematic level circuit models were then derived from these simulations. Data derived from the 3D simulations schematic models determine the electrical specifications for the Grypper G80 socket.

| P2A Configuration | P8A Configuration | Pitches (mm), 0.45 mm Ball | Contact Part Number |
|-------------------|-------------------|----------------------------|---------------------|
| <p>Pattern 2A</p> | <p>Pattern 8A</p> | 0.8 | 104468-0016 |

ELECTRICAL SPECIFICATIONS

| 0.8 mm Pitch | P2A Configuration | P8A Configuration | Value Determination |
|---------------------------------------|---|--|--|
| Time Delay | 15.0 pS | 13.7 pS | Inverse Fast Fourier transform on the transmission, S21, S-parameter. |
| Short Circuit Inductance | 0.94 nH | 0.70 nH | Values are determined by a short-circuit one-port model at 1 GHz. |
| Open Circuit Capacitance | 0.247 pF | 0.308 pF | Values are determined by an open-circuit one-port model at 1 GHz. |
| S21 Insertion Loss S11 Return Loss | -1 dB @ 34.3 GHz -10 dB @ 33 GHz -20 dB @ 3.8 GHz | -1 dB > 40 GHz -10 dB > 40 GHz -20 dB @ 15 GHz | Values are based on the 3D model results. |
| Impedance | 61.7 Ω | 47.7 Ω | Value calculated from Short Circuit Inductance and Open Circuit Capacitance. |
| Crosstalk, S41, GSSG Thru | -20dB @ 5.3 GHz | N/A | Values are based on the 3D model results. |

RESULTS FOR PATTERN 2A

3D Model Simulations for Pattern 2A

Three dimensional EM field simulations were performed using Ansoft's High Frequency Structure Simulator (HFSS™) software. Measurement ports are located at the contact points on the top, Port 1, and bottom, Port 2, of the socket. This model was updated to reflect the UV cured silicone based adhesive shown in light gray.

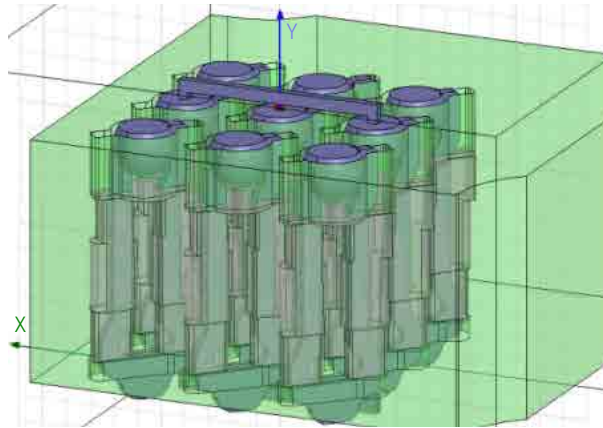

Figure 1. 1.0 mm GSG P2A model configuration

Figure 2 and Figure 3 show results for the GSG 2-port configuration at 0.8 mm pitch.

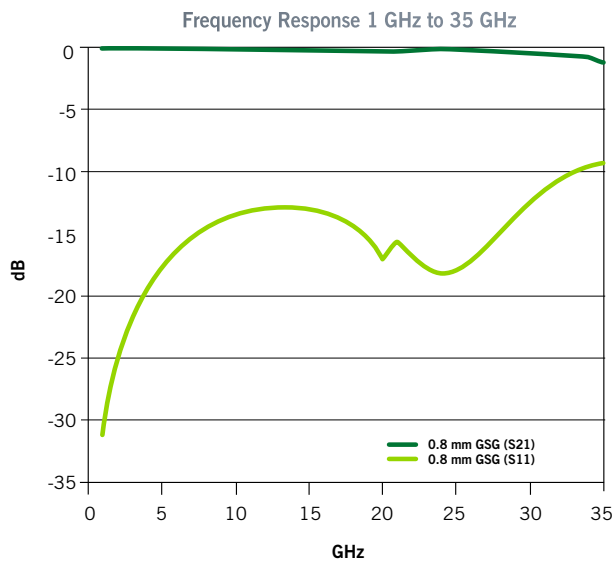

Figure 2. GSG P2A Insertion Loss and Return Loss, 0.8 mm pitch

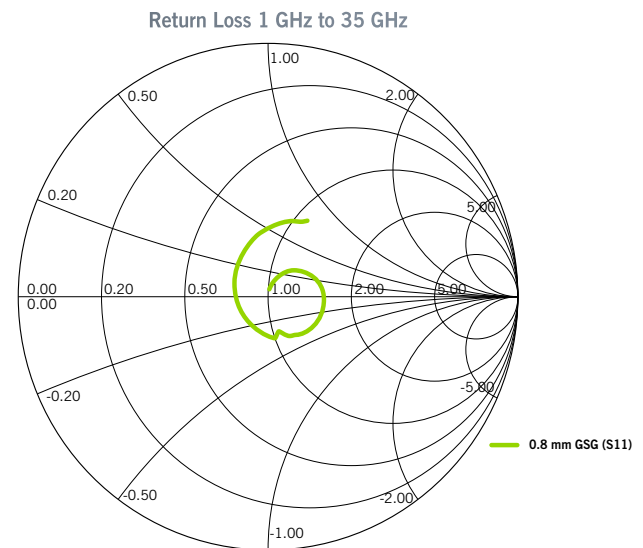

Figure 3. GSG P2A Return Loss plotted on Smith chart, 0.8 mm pitch

Measurements for Pattern 2A

P2A measurements are not available at this time.

Schematic Model for Pattern 2A Configuration

Agilent's Advanced Design System (ADS) was used to construct a GSG schematic model matching the 0.8 mm pitch socket simulation results. The topology selected matches that of the three contacts used in the simulation. The GSG schematic model consists of ten passive components. The signal contact is represented along the top by series inductors totaling 748 pH series inductor. The two ground return paths are joined together in parallel and represented along the bottom series inductors, totaling 374 pH. Shunt capacitors bridge the signal contact and the ground return path. Total capacitance is 229 fF. Finally, an added mutual inductance 60 pH represents the mutual coupling between the two ground contacts and signal.

RESULTS FOR PATTERN 2A CONT...

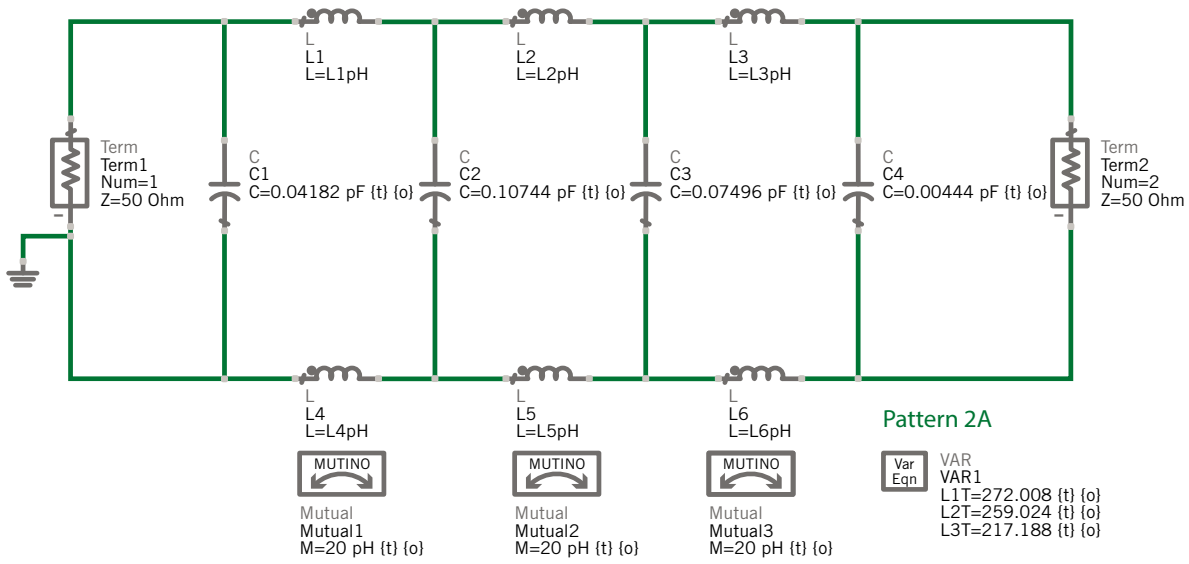

Figure 4. GSG P2A Schematic Model, 0.8 mm pitch

An additional pair of ports (ports 3 and 4 not shown) were added in the simulation to compare the schematic model to the GSG HFSS™ simulation file.

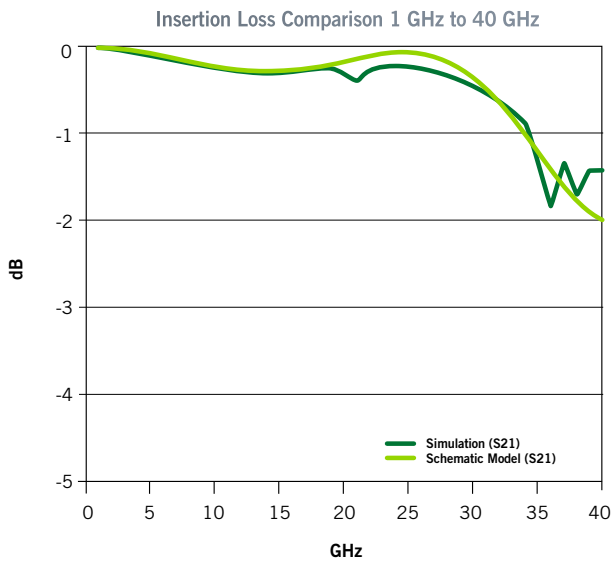

Figure 5. GSG P2A Insertion Loss, 0.8 mm pitch

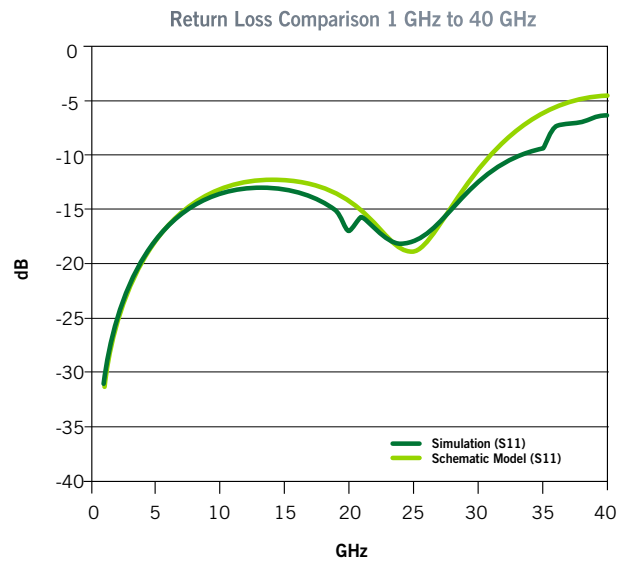

Figure 6. GSG P2A Return Loss, 0.8 mm pitch

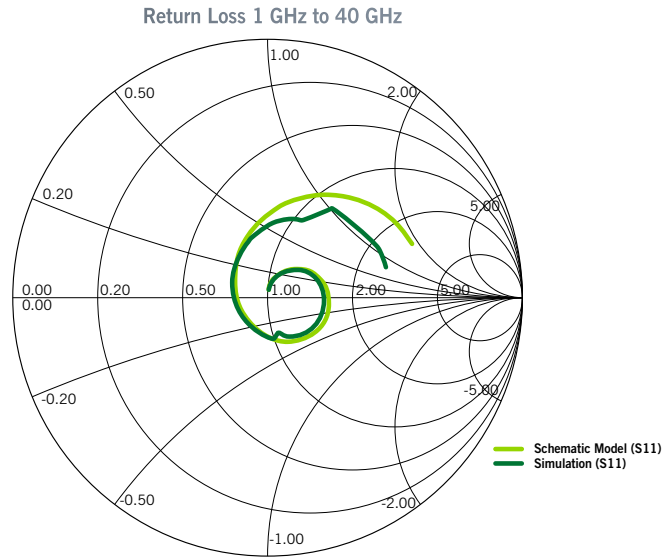

Figure 7. GSG P2A Return Loss plotted on Smith chart, 0.8 mm pitch

RESULTS FOR PATTERN 8A

3D Model Simulations for Pattern 8A

Three dimensional EM field simulations were performed using Ansoft's High Frequency Structure Simulator (HFSS™) software. Measurement ports are located at the contact points on the top, Port 1, and bottom, Port 2, of the socket. This model was updated to reflect the UV cured silicone based adhesive shown in light gray.

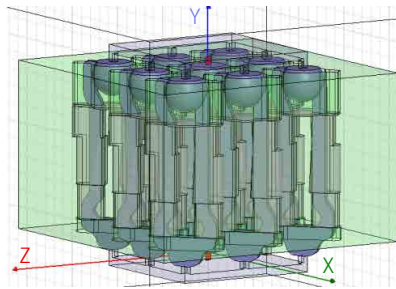

Figure 8. 0.8 mm GSG P8A model configuration

Figure 9 and Figure 10 show results for the GSG P8A 2-port configuration 0.8 mm pitch.

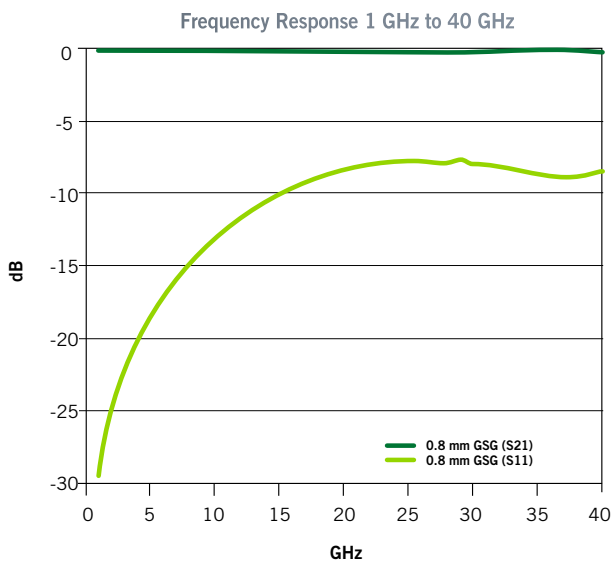

Figure 9. GSG P8A Insertion Loss and Return loss, 0.8 mm pitch

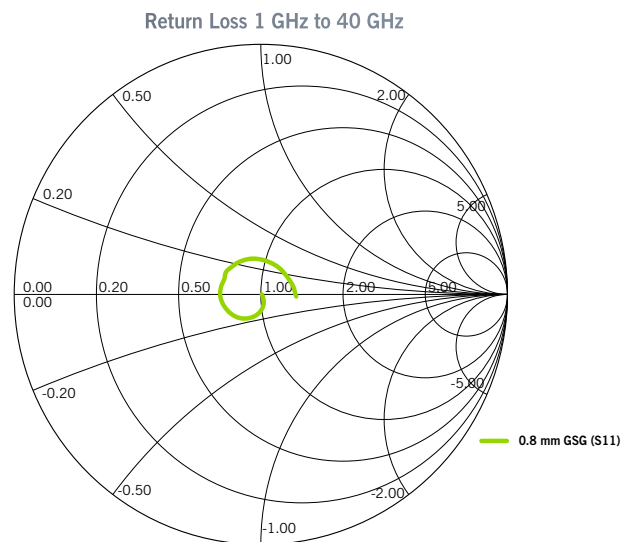

Figure 10. GSG P8A Return Loss plotted on Smith chart, 0.8 mm pitch

RESULTS FOR PATTERN 8A CONT...

Measurements for Pattern 8A

P8A measurements are not available at this time.

Schematic Model for Pattern 8A Configuration

Agilent's Advanced Design System (ADS) was used to construct a GSG schematic model matching the 0.8 mm pitch socket simulation results. The topology selected matches that of the one signal contact surrounded by eight ground contacts used in the simulation. The GSG schematic model consists of ten passive components. The signal contact is represented along the top by series inductors totaling 768 pH series inductor. The eight return paths are joined together in parallel and represented along the bottom series inductors, totaling 96 pH. Shunt capacitors bridge the signal contact and the ground return path. Total capacitance is 303 fF. Finally, an added mutual inductance 71 pH represents the mutual coupling between the ground contact and signal.

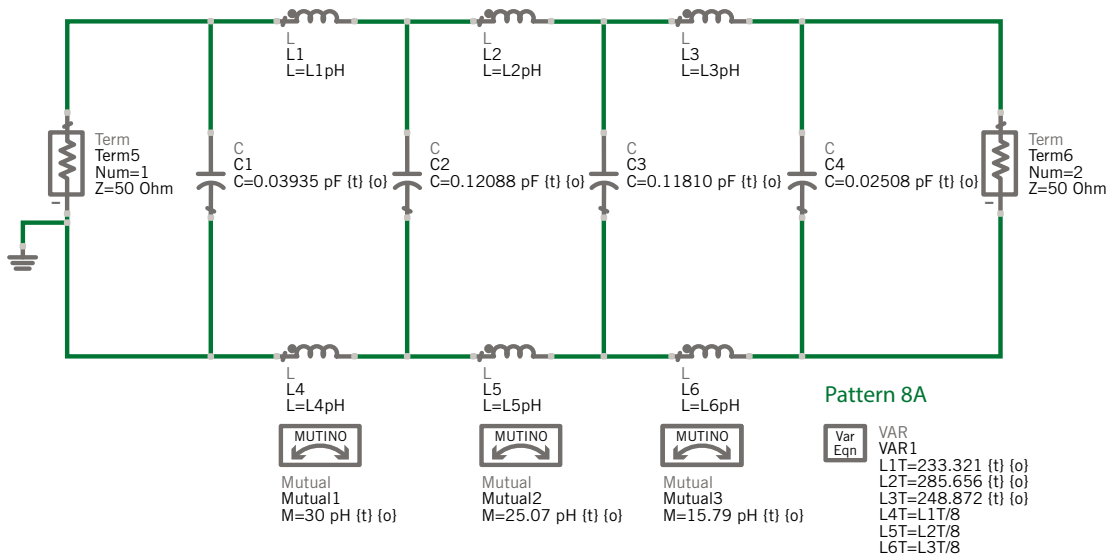

Figure 11. GSG P8A Schematic Model, 0.8 mm pitch

An additional pair of ports (ports 3 and 4, not shown) were added in the simulation to compare the schematic model to the GSG HFSS™ simulation file.

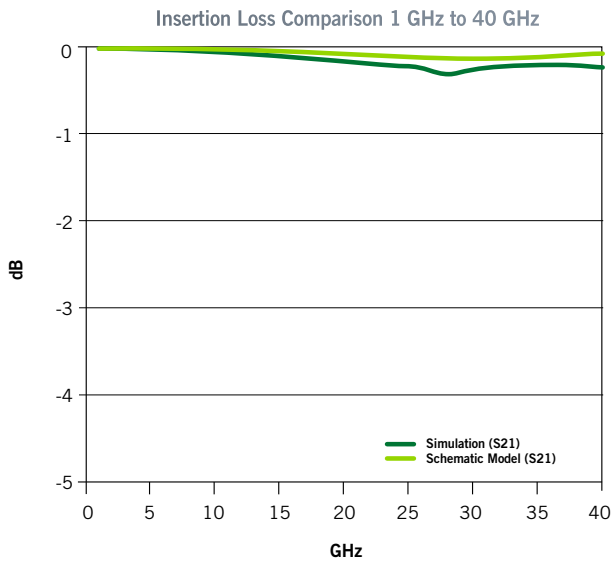

Figure 12. GSG P8A Insertion Loss, 0.8 mm pitch

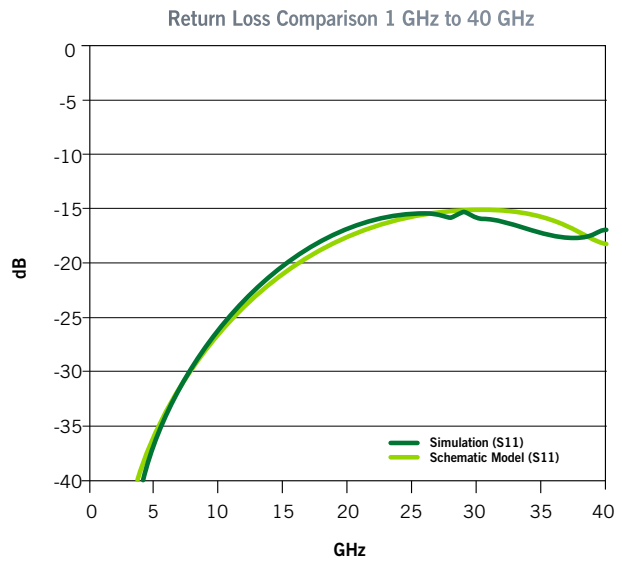

Figure 13. GSG P8A Return Loss, 0.8 mm pitch

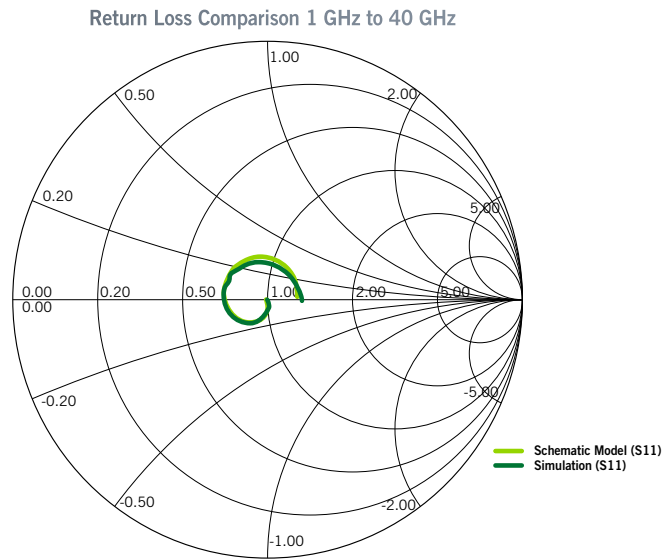
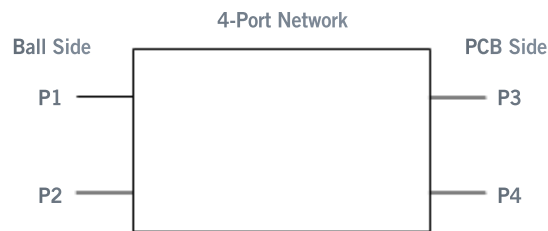

Figure 14. GSG P8A Return Loss plotted on Smith chart, 0.8 mm pitch

GSSG CROSSTALK ANALYSIS

A 4-Port S-parameter analysis was done to determine the Near End (S21) and Far End (S41) crosstalk.



Far End and Near End Crosstalk for GSSG at 0.8 mm Pitch

The model was analyzed in HFSS™.

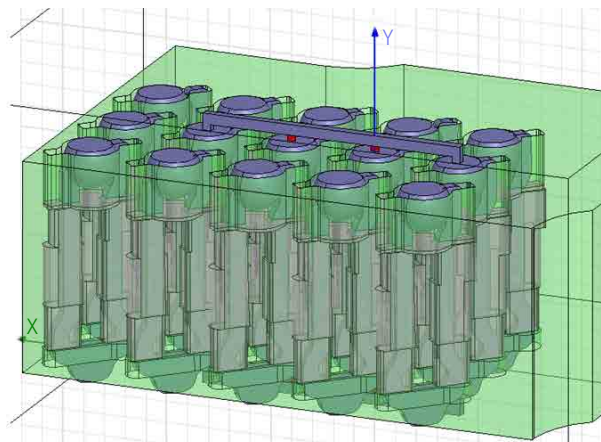

Figure 15. 0.8 mm GSSG model configuration

GSSG CROSSTALK ANALYSIS CONT...

The plot shows the results for the G80 with the 0.8 mm pitch. The -20 dB Far End crosstalk limit (10% voltage crosstalk) is reached at 5.3 GHz.

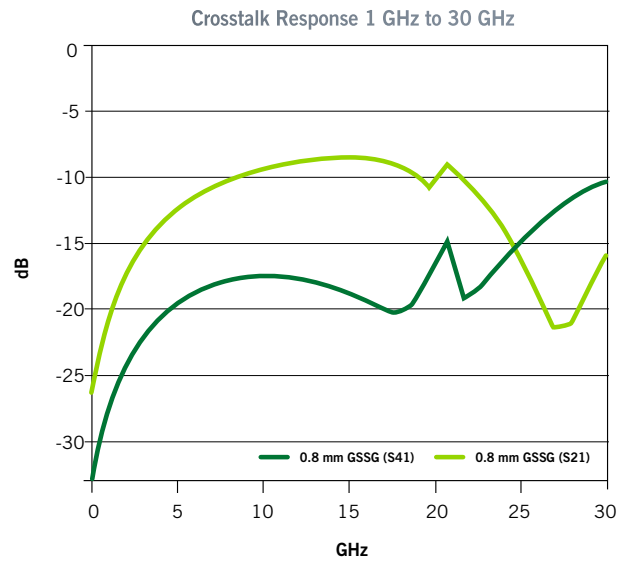

Figure 16. GSSG Crosstalk Response, 0.8 mm pitch

